

HIGH EFFICIENCY CONDENSING BOILER

Water | Natural / Propane Gas | 550-2,000 MBH | 5 Sizes
Direct Exhaust / Direct Vent | Efficiency Above 94%

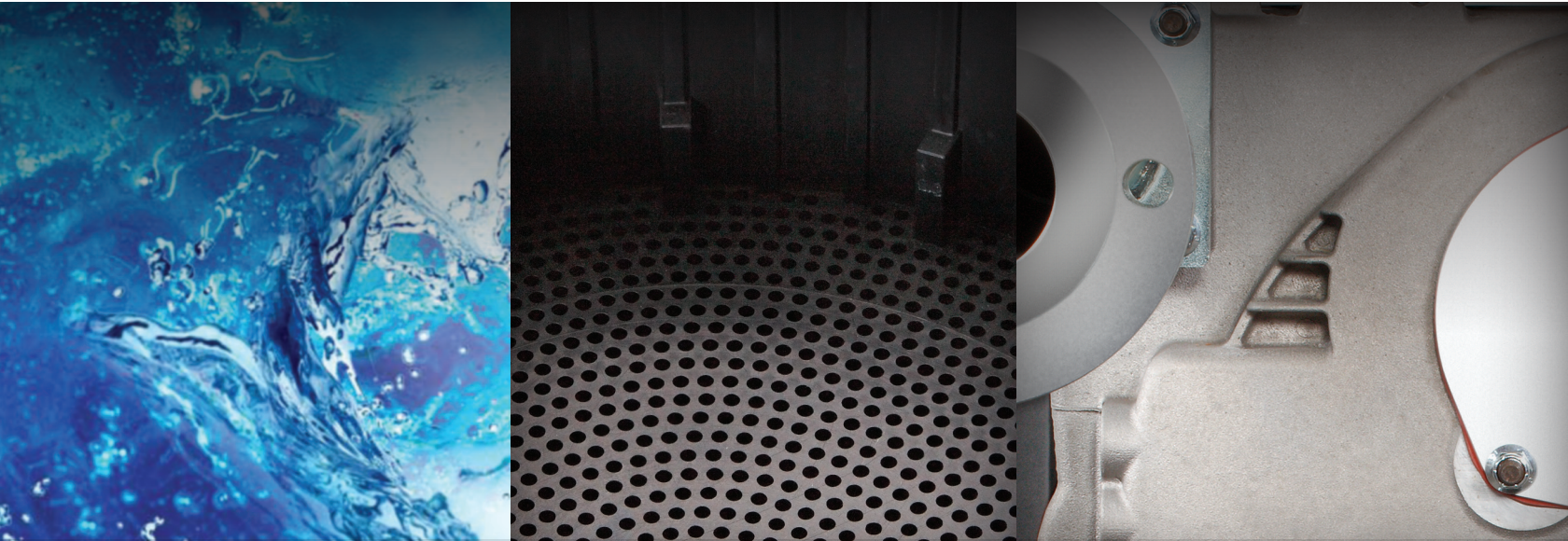

Installs fast.
Built to last.

SlimFit®

HIGH EFFICIENCY CONDENSING BOILER



+Model Dependent

EASY TO INSTALL

The SlimFit® high efficiency condensing boilers are designed for fast, easy installation in new and existing commercial and institutional settings, including religious, educational and government buildings. The units connect easily on-site — lowering installation costs and ensuring timely project completion.

Multiple Direct Exhaust and Vent Options

Venting can be either direct exhaust or direct vent. Acceptable materials include PVC, CPVC, PP and SS (AL29-4C). Maximum vent lengths for fresh air intake and exhaust are up to 100 ft. each.

Durable Aluminum Heat Exchanger

Cast aluminum sectional block provides 12 times better heat transfer than stainless steel.

Fully Modulating Burner

High-grade single stainless steel burner covered with fiber mesh fires along the entire length of the combustion area. Smart boiler controls provide full combustion modulation with 5:1 turndown ratio (SF550, SF750) and 6:1 turndown ratio (SF1000, SF1500, SF2000).

Variable Speed Motor

Precise mix of fuel and air is automatically controlled by adjusting fan speed for optimal boiler performance within its entire firing range. The integrated boiler controls constantly match combustion output to building heating needs.

Composite Base

Non-metallic heat exchanger base protects against corrosion due to aggressive condensate resulting in long-lasting service backed by industry-leading ten year non-prorated heat exchanger warranty. All other components come with two year warranty as standard.

Plug and Play Operation

Each unit is factory wired, pre-programmed, test fired and comes with factory provided test certificate.

Common Venting

Common venting is allowed in an engineered Category II vent system on the SlimFit commercial boilers sizes 550 MBH, 750 MBH, 1000 MBH, 1500 MBH and 2000 MBH under the following conditions:

- Maximum number of boilers allowed to be connected to a common duct is 8 (eight)
- All boilers in the common vent system must be the same size
- Vertical vent only
- Direct exhaust (combustion air from the boiler room) only should be considered

CSD-1 is Standard

- High & low gas pressure switches (with manual reset and indicator light)
- Manual reset low water cut-off (LWCO)
- Adjustable manual reset high limit
- UL-353 certified limit controls
- Factory test report shipped with boiler

Modulating Gas Valve

Safe and reliable operation is provided by a negative pressure regulating gas valve even when supply gas pressure is as low as 3 inches of water column.

Application Based Controls

- Hybrid boiler plants
- Variable primary only systems

550-750 MBH



1000-2000 MBH



SlimFit[®]

The Right Fit for Retrofit

The SlimFit is the fastest, easiest solution for limited-space retrofit.

Features an exceptionally small footprint

Can be installed back-to-back

Narrow design allows unit to maneuver into existing spaces

Fully factory-assembled and -tested for quick, on-site installation.

Easily integrates with older, non-condensing boilers

Increases efficiency by creating a hybrid system

Can be split into two smaller sections for difficult to access areas⁽¹⁾

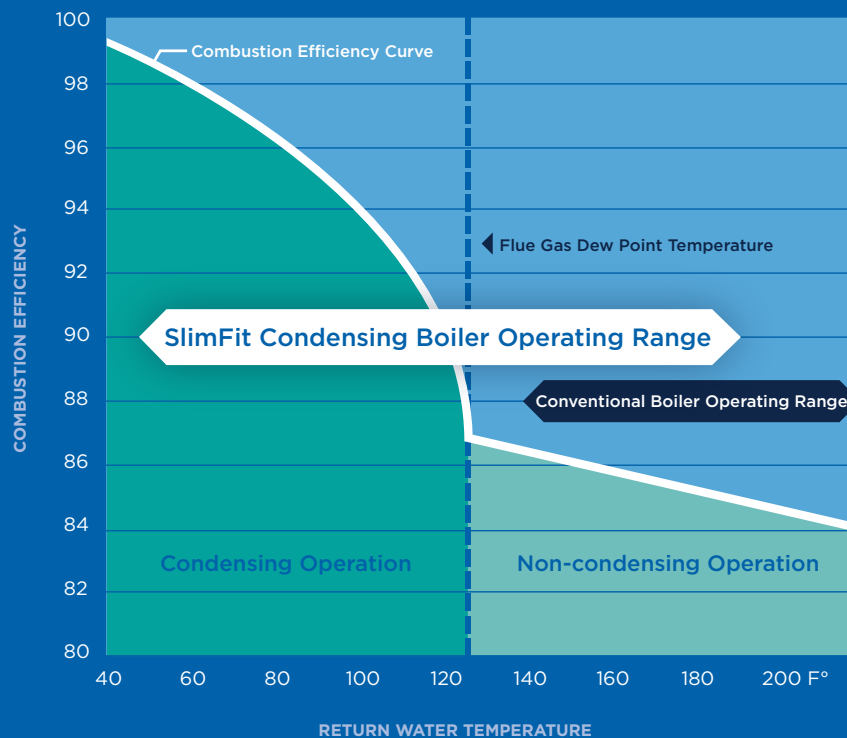

The SlimFit operates at optimal efficiency during low-load periods and non-condensing boilers operate at optimal efficiency during high-load periods. When used together in a hybrid boiler system, the two types of boilers maximize overall energy savings.

⁽¹⁾ SlimFit 1000-2000 MBH

EASY TO OWN

The SlimFit boilers deliver long-lasting benefits. Facility owners and managers depend on our dedicated customer service, reliable product performance and exceptional operating efficiency for decades of value.

DEDICATED CUSTOMER SERVICE

Local, trained heating professionals are available for help with installation and maintenance. Our technical service department is also available for questions and assistance with troubleshooting.

RELIABLE PRODUCT PERFORMANCE

Each factory-configured and-tested unit arrives ready for a lifetime of smooth operation.

- Exclusive, durable, non-metallic base material prevents corrosion over time
- Industry-leading non-prorated warranty covers heat exchanger (10 years) and parts (two years)
- Low NOx < 20 ppm
- **Thousands of successful installations since 2009**

EXCEPTIONAL OPERATING EFFICIENCY

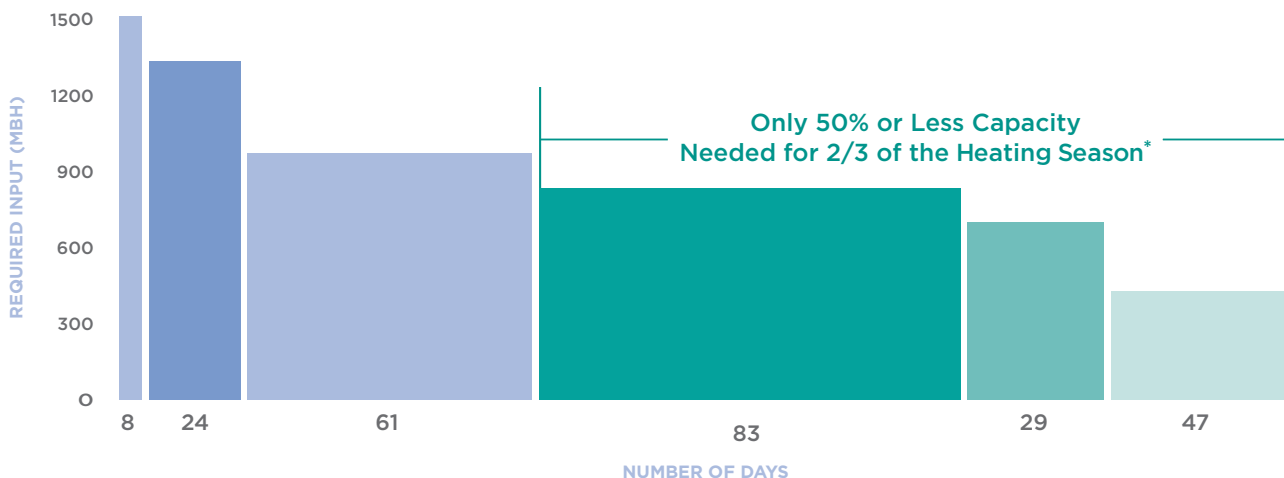

The SlimFit boiler runs at optimal efficiency — lowering operating costs, contributing to LEED points and meeting future requirements for green building operation. With maximum combustion efficiency of 96.1% and thermal efficiency of 95.8%, the SlimFit satisfies the same needs that could be provided by a larger system — but without the bulkiness or inefficiency. Its advanced modulating controls allow the SlimFit to effectively meet annual demand through its lead/lag functionality and lead boiler rotation.

* Based on an average building in a 0°F design area.

The SlimFit 1000-2000 MBH features for quick and easy installation.

Wheels for Easy Positioning

Caster wheels make positioning easy and lock to keep the unit in place. They can also be removed to secure the mounting points for seismic applications. The legs can be individually adjusted to level the SlimFit.

Quick Set-Up, System Compatible Controls

Each unit comes with factory pre-configured controls ready for express set up. The advanced control system is 0-10V set point adjustable and BAS communication capable.

Lead / Lag

Lead/lag compatibility with up to 8 boiler string modulation for improved performance (comfort

level) and lead boiler rotation for equal run hours (longer equipment life and efficiency). Standard features also include warm weather shutdown and frost protection.

Versatile Orientation

The SlimFit makes it easy to connect multiple units together in any space. Right-hand and left-hand orientations allow for side-by-side installations, making all clean-out plates and piping easily accessible. The control display can be mounted in one of the two locations, the long side of the boiler or the short end of the boiler.

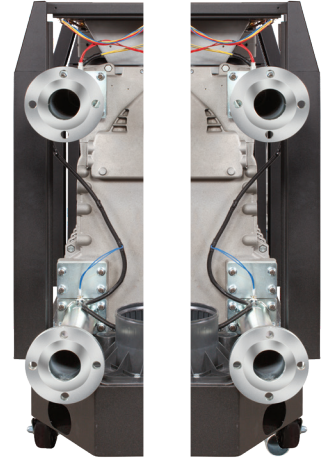

LEFT HAND CONFIGURATION

RIGHT HAND CONFIGURATION

SlimFit 1000-2000 MBH Disassembly Figure

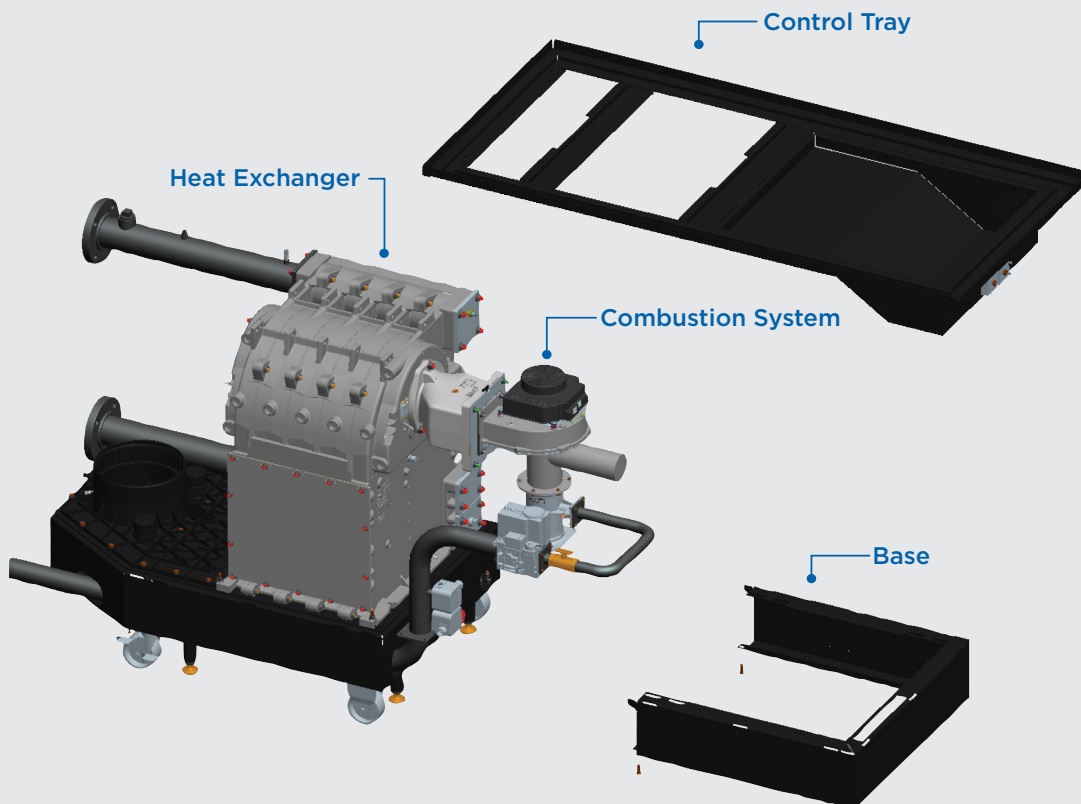

Small Footprint

The unit fits through typical doorways and can be quickly disassembled for installation in extremely tight access areas. Flexible configuration allows for side-by-side installation, further minimizing the overall project footprint.

Boiler can be disassembled into (4) separate sections:

- Base
- Combustion System
- Control Tray
- Heat Exchanger

550-2000 MBH SPECIFICATIONS

MODEL	INPUT MAXIMUM (MBH)	INPUT MINIMUM (MBH)	GROSS OUTPUT (MBH)	NET AHRI (MBH)	COMBUSTION EFFICIENCY	THERMAL EFFICIENCY	VENT MATERIAL	VENT / AIR SIZE	VENT / AIR LENGTH	MINIMUM GAS PRESSURE (WC)	SUPPLY / RETURN CONNECTIONS	GAS CONNECTION SIZE	FULL LENGTH
SF550	550	110	517	450	94.7%	93.9%	PVC, CPVC, PP, SS (AL29-4C)	6"	100'	3.5"	2" NPT Male	1 1/4" NPT Male	47 1/4"
SF750	750	150	702	610	94.0%	93.6%	PVC, CPVC, PP, SS (AL29-4C)	6"or8"	30' or 100'	3.5"	2" NPT Male	1 1/4" NPT Male	47 1/4"
SF1000	1,000	167	958	833	96.1%	95.8%	PVC, CPVC, PP, SS (AL29-4C)	6"or8"	100' or 150'	3"	3" ASME Class 150 Flange	2" NPT Male	77 15/16"
SF1500	1,500	250	1,437	1,250	95.9%	95.8%	PVC, CPVC, PP, SS (AL29-4C)	8"	100'	3"	3" ASME Class 150 Flange	2" NPT Male	77 15/16"
SF2000	2,000	333	1,906	1,657	95.8%	95.3%	PVC, CPVC, PP, SS (AL29-4C)	8"	100'	3"	3" ASME Class 150 Flange	2" NPT Male	90 3/16"

SLIMFIT 550-2000 MBH BOILERS - SMART CONTROL FEATURES

- 3.5" LCD screen
- Intuitive, color coded display
- Express set up or fully customizable options
- Modbus® standard, BACnet® optional
- Preset typical heating systems
- 0-10 VDC analog output signal to modulate a lag boiler in a hybrid boiler system
- Up to 8 boiler cascading and lead/lag rotation
- Multiple boiler operation with up to 24 circulators
- ZoneStacking™ - zone and priority options for up to 24 programmable zones.
- SmartSequencing™
- Alarms and advanced diagnostics
- High limit and modulating temperature control
- Boiler staging algorithm optimized for variable primary only systems
- Outdoor temperature reset and warm weather shutdown
- Boiler schedule and contractor information
- Low water protection
- High temperature limit with manual reset
- Ignition control
- Multiple inputs with assignable priority



Weil-McLain® offers BIM-Revit® product content to help Architects, MEP, Structural Engineers, and Contractors design projects accurately and efficiently.

550-750 MBH SPECIFICATIONS

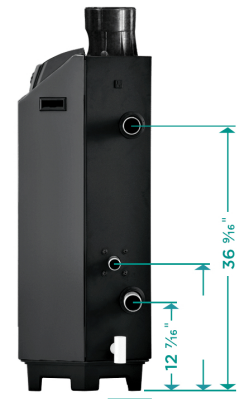
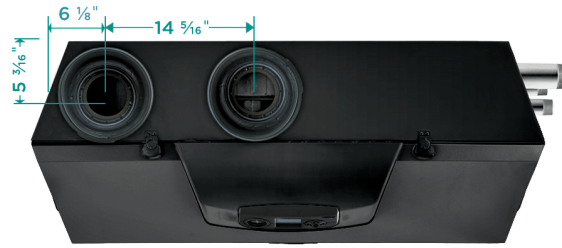

1000-2000 MBH SPECIFICATIONS

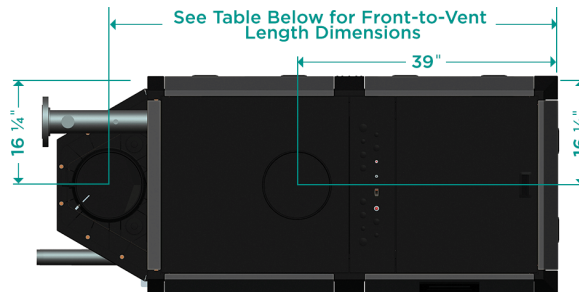

MODEL	FRONT-TO-VENT LENGTH
SF1000	67 1/16"
SF1500	67 1/16"
SF2000	79 1/4"

Contact your local Weil-McLain sales office for more information.

CENTRAL AND WESTERN SALES

999 McClintock Drive
Suite 200
Burr Ridge, IL 60527
TEL: 630-560-3738
FAX: 855-248-2777
Toll Free: 800-854-5482

ADMINISTRATIVE OFFICE

999 McClintock Drive
Suite 200
Burr Ridge, IL 60527
TEL: 630-560-3700
FAX: 630-560-3769

Weil-McLain® is a leading North American designer and manufacturer of hydronic comfort heating systems for residential, commercial and institutional buildings since 1881. Weil-McLain has manufacturing facilities in Michigan City, Indiana and Eden, North Carolina, along with regional sales offices throughout the United States and an administrative office in Burr Ridge, Illinois. Building on a reputation of quality and innovation, Weil-McLain is committed to creating Simplified Solutions for our Complex World™.

Architects, engineers, contractors, facility managers and homeowners alike rely on Weil-McLain for their comfort heating needs. Installed in homes, offices, schools, restaurants, hotels and other facilities throughout North America, the Weil-McLain brand is among the most respected and often used in the building industry.

Weil-McLain hydronic boilers and indirect-fired water heaters integrate the latest in advanced controls and materials including cast iron, stainless steel and aluminum heat exchanger technologies. The reliability and energy efficiency of our products has helped to make Weil-McLain industry leaders. Products are engineered with aesthetics, functionality, safety and structural tolerance in mind. By combining our expertise with the responsiveness of our support operations, we provide our customers with added value and peace of mind.



weil-mclain.com